

A Guide to Orientating 3-C Geochain data using HSI devices

DISCLAIMER:

This document has been produced to serve as a general guide to appropriate HSI implementation during 3-C orientation routines. Survey and hardware/software configurations may differ to that shown in the following examples, which may in turn affect the suitability of the demonstrated rotation methodology.

Avalon Sciences Ltd (ASL) takes no responsibility for any erroneous data output as a result of following this guide. It is highly recommended to always consult your technical processing manager to QC and approve your orientation route before implementing a 3C rotation routine.



Introduction to HSI

The new X-Series digitizer (AS272) and slim (AS251) electronics have been recently implemented with a 3C solid state inclinometer system called a **High Side Indicator (HSI)**, which measures the direction of the pull of gravity and calculates the angles of roll and vertical inclination in each shuttle of the Geochain™ /GeochainSlim toolstring.

The integrated system denotes tool inclination from vertical (DEV Angle 0-90°) and clockwise roll looking downhole (Relative Bearing RB angle +180°) .

Roll and inclination angles are determined from an accelerometer subsystem measuring the direction of the pull of gravity. If combined with a well deviation listing giving well azimuth trajectory (HAZI 0-360°), full 3-C processing can be achieved for all 3 components delivering a Vertical Up and Horizontal North/West field orientated dataset.

The current accuracy of the accelerometers tested for inclination measurement is $\pm 0.1^\circ$ with tool roll accuracy $\pm 0.25^\circ$ when positioned $>10^\circ$ from vertical.



COMPATIBLE WITH

LEADERS IN BOREHOLE SEISMIC TECHNOLOGY

The integrated system denotes tool inclination from vertical and clockwise roll (looking downhole).



Tool Roll Values exported in raw data headers – Displayed as a Well View attribute (VSProwess)

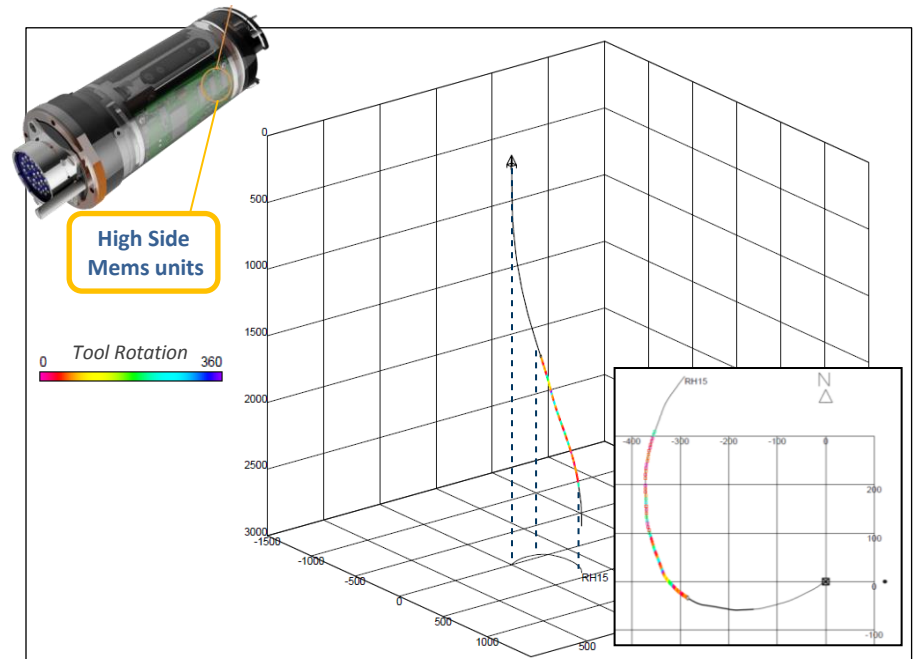



HSI for Tool QC

- The high side indicator can be monitored in real time during well deployment to allow field engineer to QC tool vector fidelity and receiver-receiver roll move out.
- Measures tool roll and inclination for every receiver for full 3-C geophone orientation
- Real time monitor read out and manual capture utility (along with internal electronics temperature)
- Automatic addition of HSI data to MIRF-6 header for each individual record
- Automatic calibration for optimal accuracy at various tool temperatures
- The user can also manually capture the readout for all tools. (can be automatically correlated with Welltrack deviation listing in ACQ).

COMPATIBLE WITH

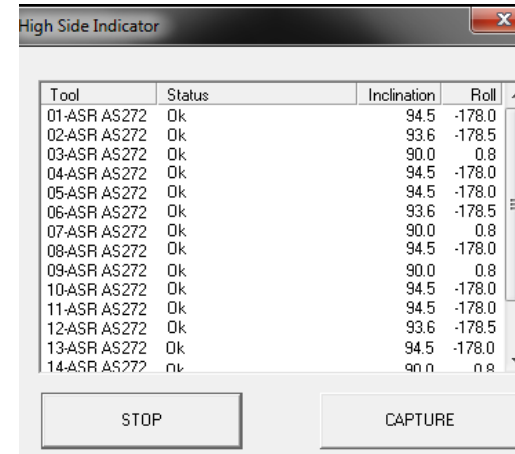
Tool	Status	Inclination	Roll
01-ASR AS272	Ok	94.5	-178.0
02-ASR AS272	Ok	93.6	-178.5
03-ASR AS272	Ok	90.0	0.8
04-ASR AS272	Ok	94.5	-178.0
05-ASR AS272	Ok	94.5	-178.0
06-ASR AS272	Ok	93.6	-178.5
07-ASR AS272	Ok	90.0	0.8
08-ASR AS272	Ok	94.5	-178.0
09-ASR AS272	Ok	90.0	0.8
10-ASR AS272	Ok	94.5	-178.0
11-ASR AS272	Ok	94.5	-178.0
12-ASR AS272	Ok	93.6	-178.5
13-ASR AS272	Ok	94.5	-178.0
14-ASR AS272	Ok	90.0	0.8

Real Time readout for each tool with live status reporting.

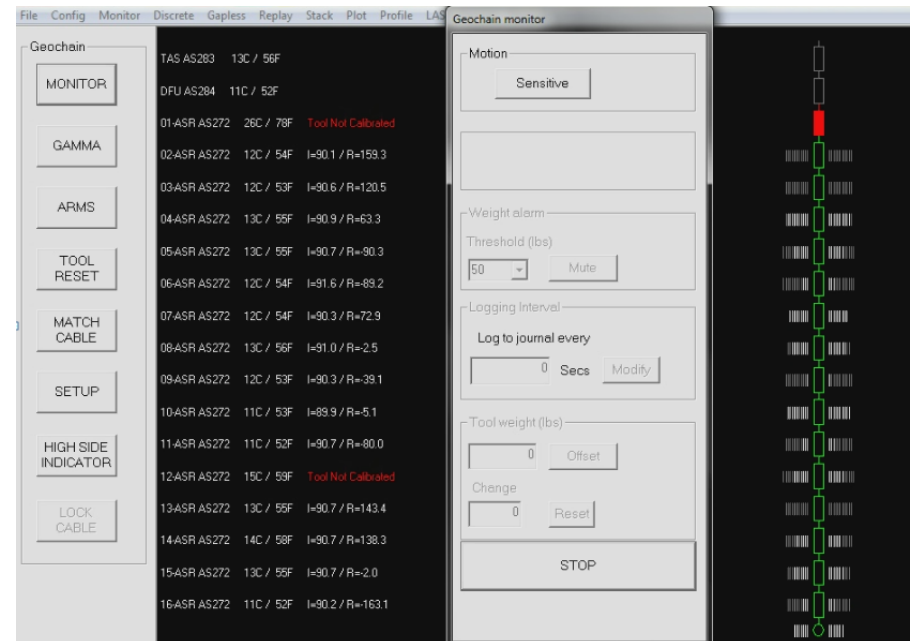

The screenshot shows the 'Geochain monitor' software interface. On the left is a sidebar with buttons: MONITOR, GAMMA, ARMS, TOOL RESET, MATCH CABLE, SETUP, HIGH SIDE INDICATOR, and LOCK CABLE. The main area displays a list of tools with their status and inclination/roll values. Some tools are marked 'Tool Not Calibrated' in red. On the right, there are control panels for 'Motion' (set to Sensitive), 'Weight alarm' (Threshold 50 lbs, Mute), 'Logging Interval' (0 Secs), and 'Tool weight (lbs)' (0 lbs, Offset, Reset). A vertical diagram on the far right shows a tool string with a red indicator at the top.

Tool Roll Values and Inclination Values displayed during "Tool Monitor" whilst tools are deployed



Main Features

- Ideal for **VSP** & **Microseismic** surveys.
- Four geophones per axis.
- Fits standard and high pressure ASR's.
- Greater signal to noise ratio.
- Modular for quick and easy customisation.

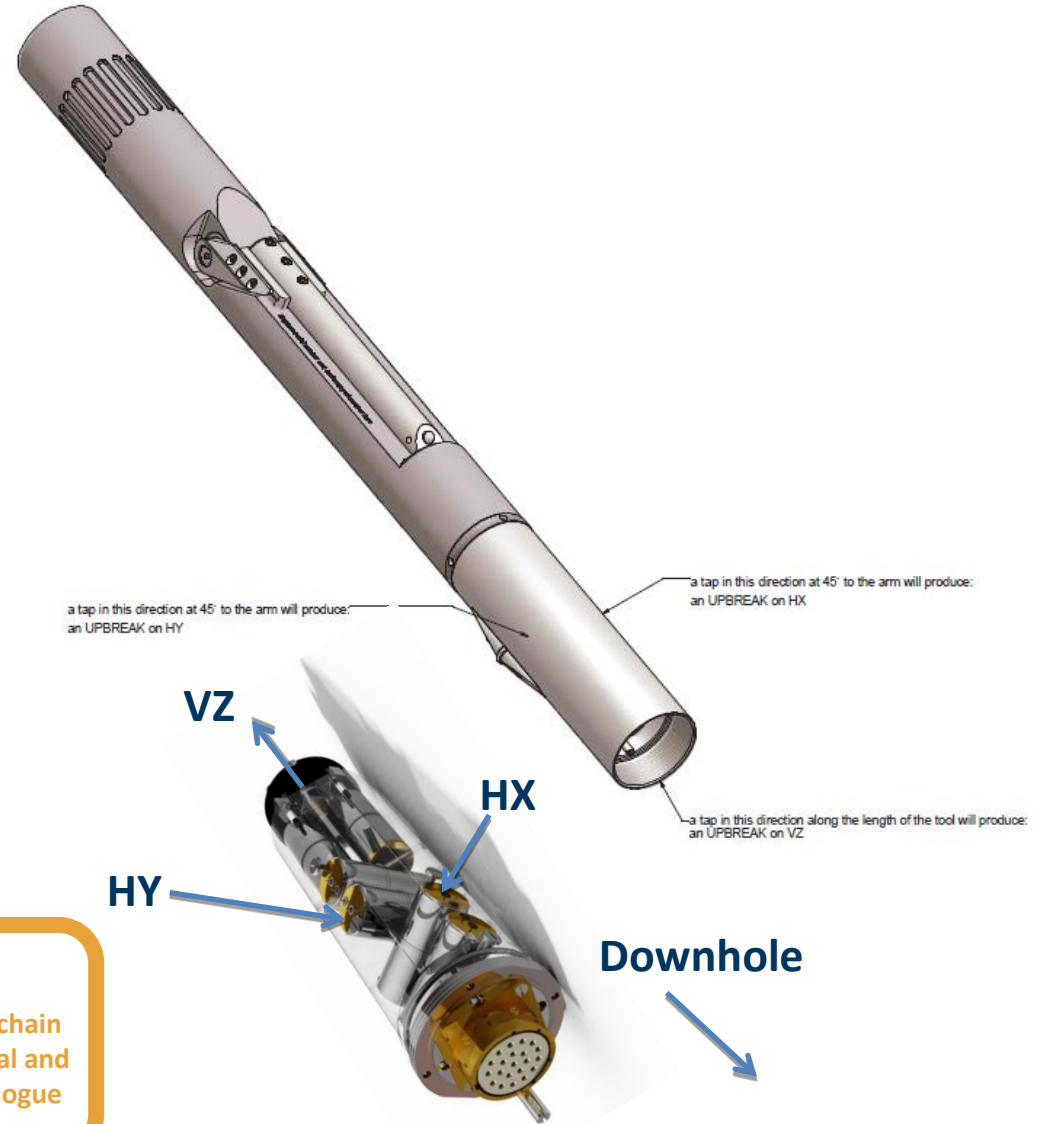

Quad vs Dual Overall Sensitivity

	Electronics	Damping Resistors	Downhole Gain	Sensitivity undamped V/m/s	Sensitivity damped V/m/s	Overall Sensitivity V/m/s	Damping 20°C
Dual	AS271	47KΩ	54dB	104	94.4	47200	0.641
Quad	AS271	47KΩ	54dB	208	172.7	86350	0.7

COMPATIBLE WITH





HSI 3-C Field Processing

- The First rotation is that of the HSI roll or relative bearing (RB) angle, which is described in the plane orthogonal to the tool axis. RB is measured clockwise looking down from the vertical plane (borehole “high side” towards the direction of the arm opening Fig (a).

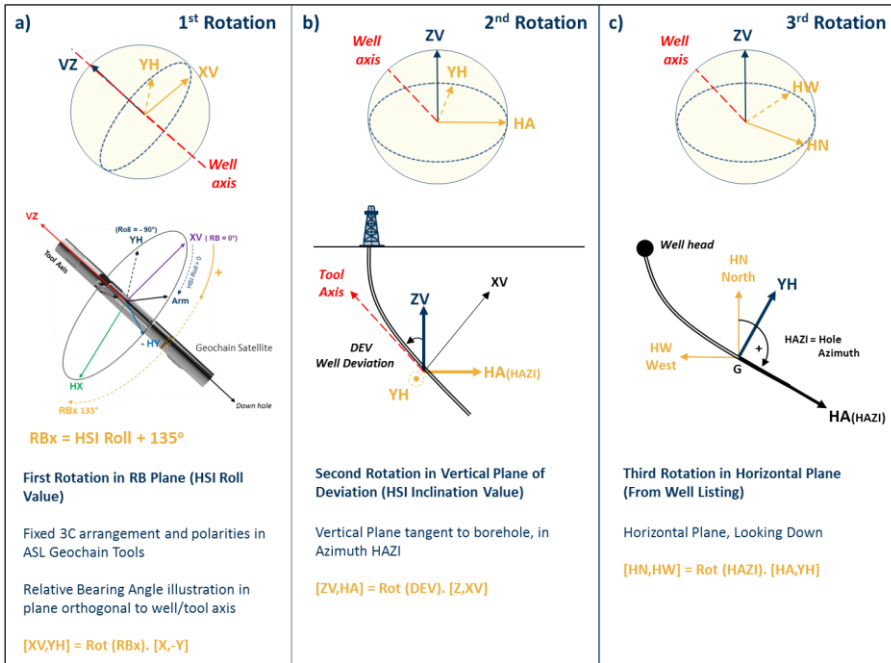

COMPATIBLE WITH



Geochain Digital

LEADERS IN BOREHOLE SEISMIC TECHNOLOGY

Below – Correlated raw common depth 3C stack plot in true amplitude, as recorded (no rotation applied).

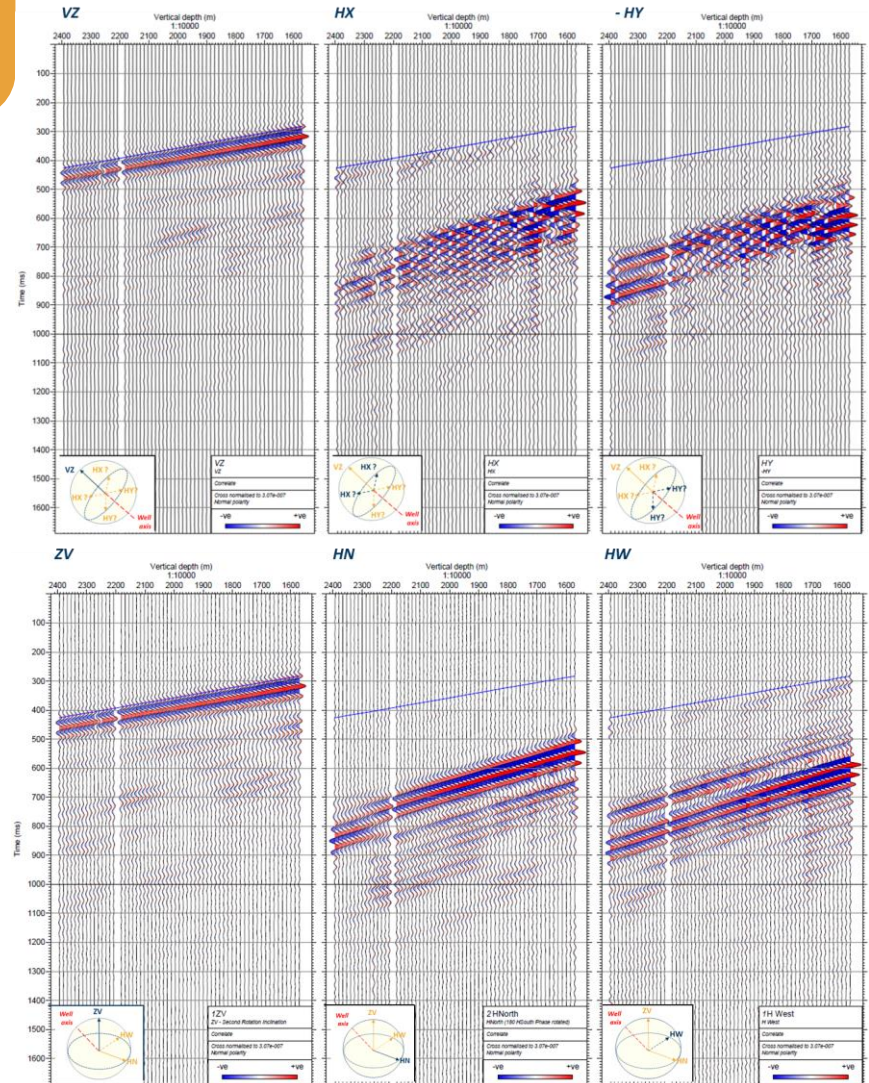

Above – Correlated common depth 3C stack plot in true amplitude, in geographic system, after three rotations. The first rotation of the X,Y raw components with the highly erratic recorded HSI roll angle, produces a great coherency between adjacent depth levels.

RAW DATA EXAMPLE

- There are two methods in ACQ software for capturing tool roll and inclination.

1. HSI MIRF Header when Recording

Every time a record is taken, the HSI Roll and HSI INC values are saved to the **MIRF-6** (and subsequent MIRF release) headers. Please see MIRF-6 specification for header location (<https://www.avalonsciences.com/wp-content/uploads/2014/05/MIRF6-Specification.pdf>).

VSProwess X users will automatically have HSI header values imported when using 'MIRFInput operators'.

2. HSI Manual Capture whilst Monitoring

A 'Manual HSI Capture' can be performed at any time whilst monitoring the tool string. This captures each tool Roll and Inclination value for each satellite and saves it instead to a CSV file within the acquisition job.

The user will be prompted to provide the depth of the reference tool prior to capture.

Care must be made when extracting the data to ensure appropriate HSI matching to the relevant traces.

Roll -179 to +180° or 1-360°?

The default **MIRF-6 header specification** stores tool roll as clockwise rotation from the tool arm pointing upwards whilst looking downhole as **-179 to +180°**.

However, the 'Manual Capture' utility allows for toggling of the HSI roll (saved to the stand alone CSV file) between **-179 to +180° and 1-360°** so as to allow easier infield QC.

Please take care to note the Roll angle setting. A column in the CSV will state Y/N for whether roll is 1-360° (N = Roll value stored as -179 to +180°).

Below – Correlated raw common depth 3C stack plot in true amplitude, as recorded (no rotation applied).

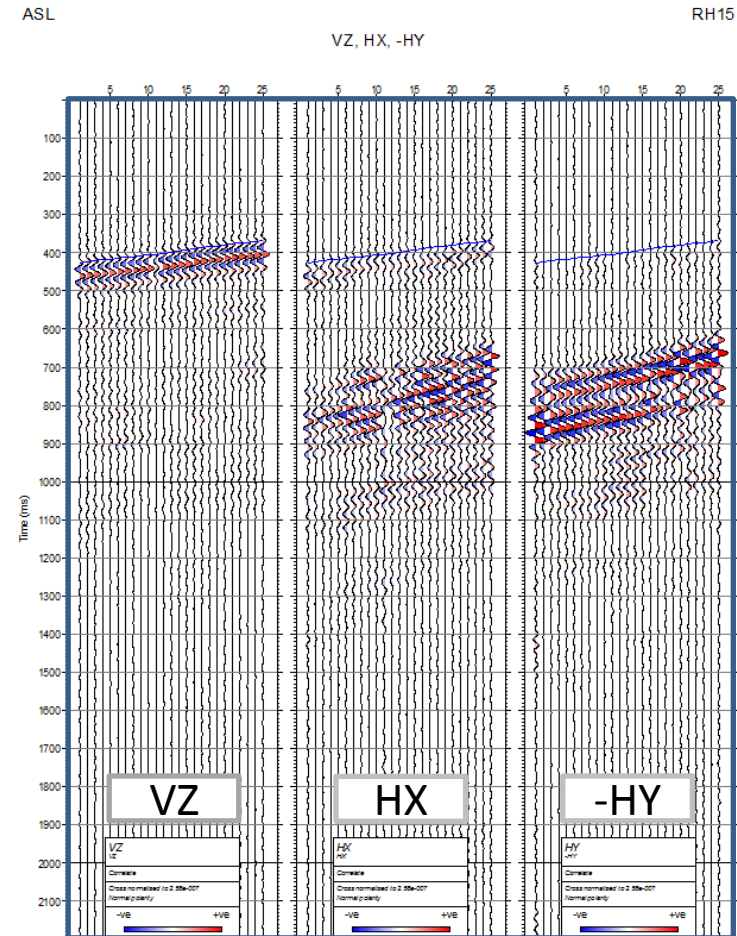

a)

1st Rotation

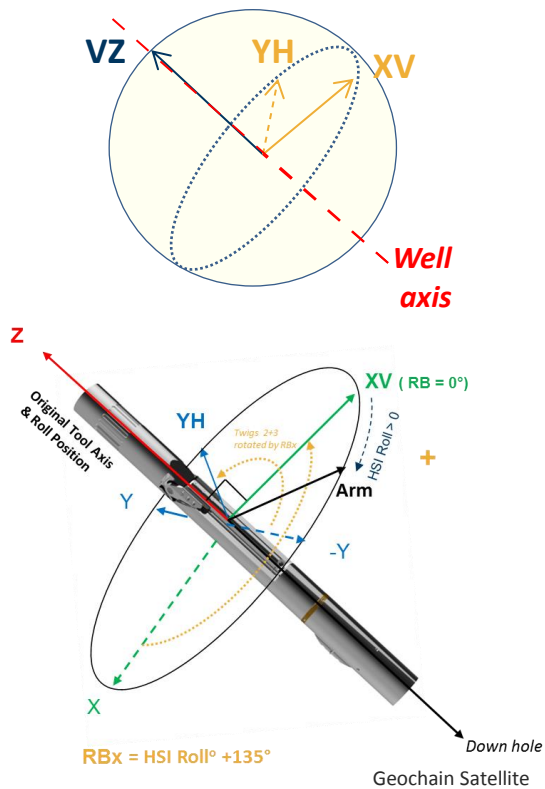

$$RBx = HSI \text{ Roll } (1-359^\circ) + 135^\circ$$

First Rotation in RB Plane (HSI Roll Value)

Fixed 3C arrangement and polarities in ASL Geochain Tools

Relative Bearing Angle illustration in plane orthogonal to well/tool axis

$$[XV, YH] = \text{Rot} (RBx) \cdot [X, -Y]$$

Assumes use of ASR-227 or ASR-223 Fixed Sensor Pack

Step 1 – First Rotation.

$$[XV, YH] = \text{Rot} (RBx) \cdot [X, -Y]$$

- i. Read in 3 component seismic traces from Mirf.rcd file
- ii. Reverse Polarity of second Y input component, to (-Y)
- iii. Correct (if applicable) the HSI Tool Roll values to be 1-360° not -179 to +180°.
- iv. Apply correction of tool high side roll angle (RB) for ASR-227/ASR-223 X component offset from Arm = RBx. This will depend on the direction of X sensor with respect to the Arm direction (RB=0 / RB origin). In this example +135° has been applied to RB to obtain RBx.
- v. Apply 'left handed' rotation, where rotation angle RBx is measured positively from first component (X) towards second component (-Y).

$$(XV, YH) = [\cos RBx, \sin RBx; -\sin RBx, \cos RBx] \cdot (X, -Y)$$

$$XV = X \cdot \cos(RBx) - Y \cdot \sin(RBx);$$

$$YH = -X \cdot \sin(RBx) - Y \cdot \cos(RBx)$$

Note on Accuracy:

The current accuracy of the accelerometers tested for inclination measurement is $\pm 0.1^\circ$ with tool roll accuracy $\pm 0.25^\circ$ when tool is positioned $>10^\circ$ from vertical*.

ASL

RH15

HSI First Rotation - (HSI +135 Normal) RB Twig 2+3

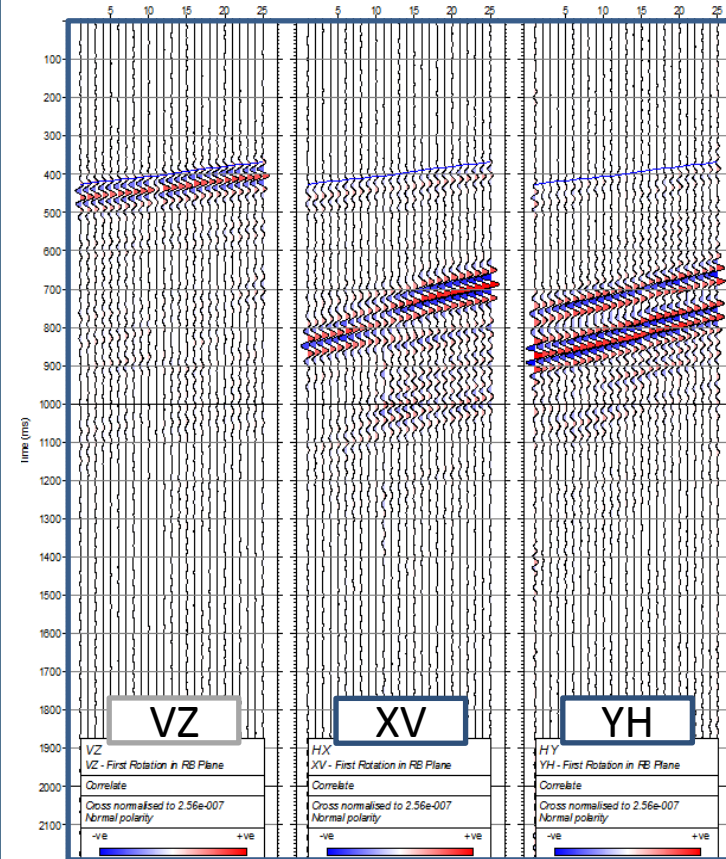

***If rotating data in wells inclined steeply below this value, you may have to resort to use the coherency of seismic body waves over adjacent VSP stations, or employ a third party compass/magnetometer tool. For reference on how to do this please see (Neville et al. 2017 VSP Tool Orientation Using Magnetometer and Inclinator Sensors. EAGE Paris Proceedings.)**

b) **2nd Rotation**

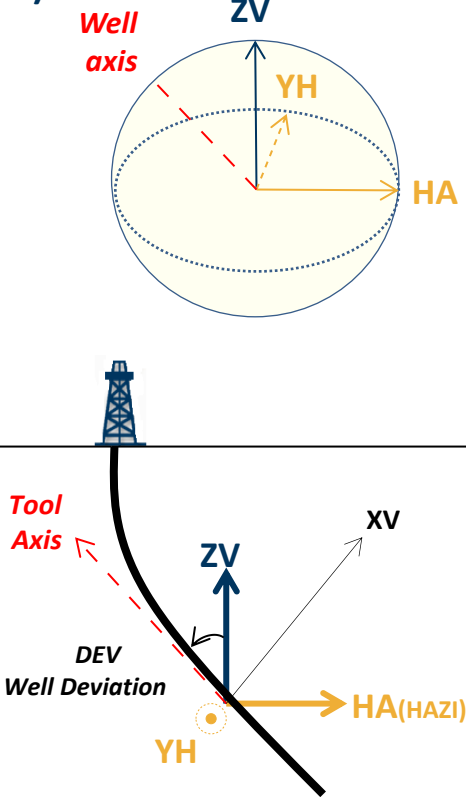

Second Rotation in Vertical Plane of Deviation (HSI Inclination Value)

Vertical Plane tangent to borehole, in Azimuth HAZI

$[ZV,HA] = Rot (DEV). [Z,XV]$

Assumes use of ASR-227 or ASR-223 Fixed Sensor Pack

Step 2 – Second Rotation.

$[ZV,HA] = Rot (DEV). [Z,XV]$

HSI Inc Angle = ‘DEV’

- i. Perform 2nd rotation on Z and XV components so as to correct for well deviation/Inclination angle. This can be from either HSI Well Inclination or from Well Deviation listing.

$(ZV,HA) = [\cos(DEV), \sin(DEV); -\sin(DEV), \cos(DEV)] * (Z,XV)$

$ZV = Z * \cos(DEV) + XV * \sin(DEV)$
 $HA = - Z * \sin(DEV) + XV * \cos(DEV)$

QC Tip:

A cross normalized trace display of ZV, HA after second rotation would generally show an increase of amplitude of direct arrival on ZV relatively to Z, and a decrease of amplitude on HA relatively to XV, in a deviated well / rig source VSP.

Cross-normalized 3C display = 3C constant gain at each depth level

ASL

RH15

HSI Second Rotation - (Tool Inc - Vertical Plane Tangent to Borehole Azi) Twig 1+2

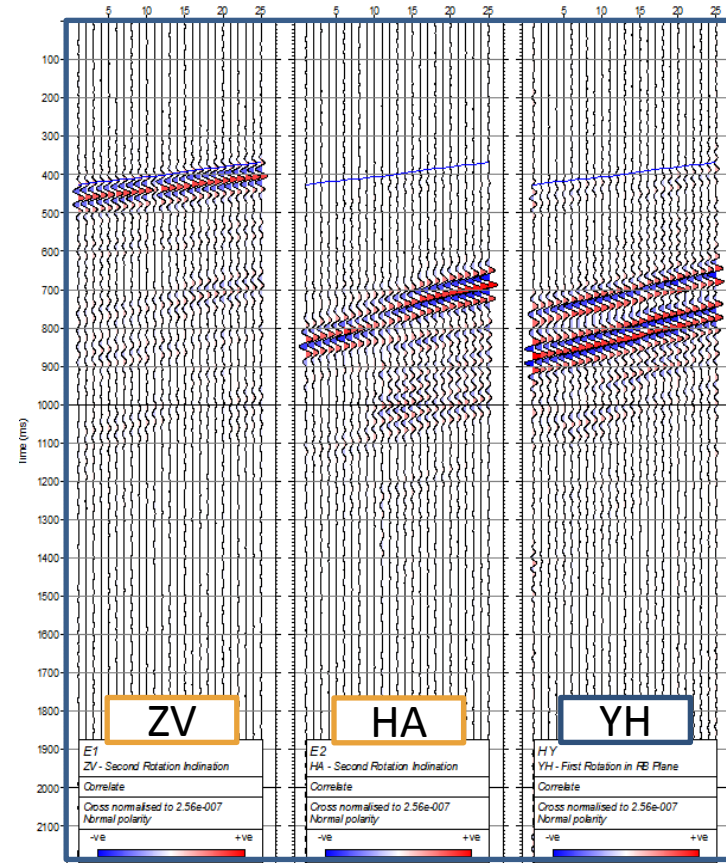

c) 3rd Rotation

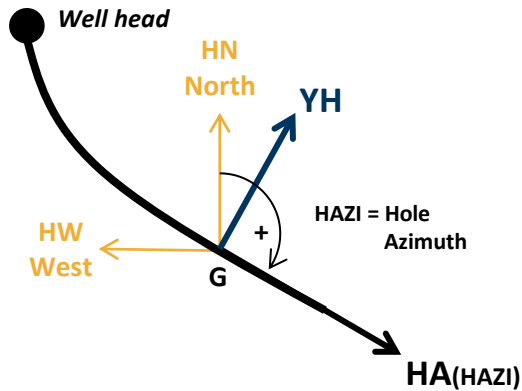
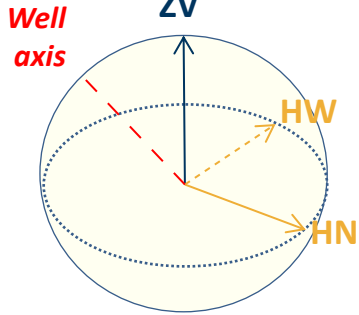

Third Rotation in Horizontal Plane
(From Well Listing)

Horizontal Plane, Looking Down

$[HN,HW] = Rot (HAZI). [HA,YH]$

Assumes use of ASR-227 or ASR-223 Fixed Sensor Pack

Step 3 – Third Rotation.

$[HN,HW] = Rot (HAZI). [HA,YH]$

Well Track Azimuth = ‘HAZI’

- i. Perform 3rd rotation on HA and YH components to correct for well azimuth angle in order to output components relative to North. The vertical ZV component points upwards.

$(HN,HW) = [\cos(HAZI), \sin(HAZI); -\sin(HAZI), \cos(HAZI)] * (HA,YH)$

$HN = HA * \cos(HAZI) + YH * \sin(HAZI)$
 $HW = -HA * \sin(HAZI) + YH * \cos(HAZI)$

Cross-normalized 3C display = 3C constant gain at each depth level

ASL

RH15

HSI Third Rotation Corrected - Horizontal Plane looking down (HAZI) - Twigs 2+3

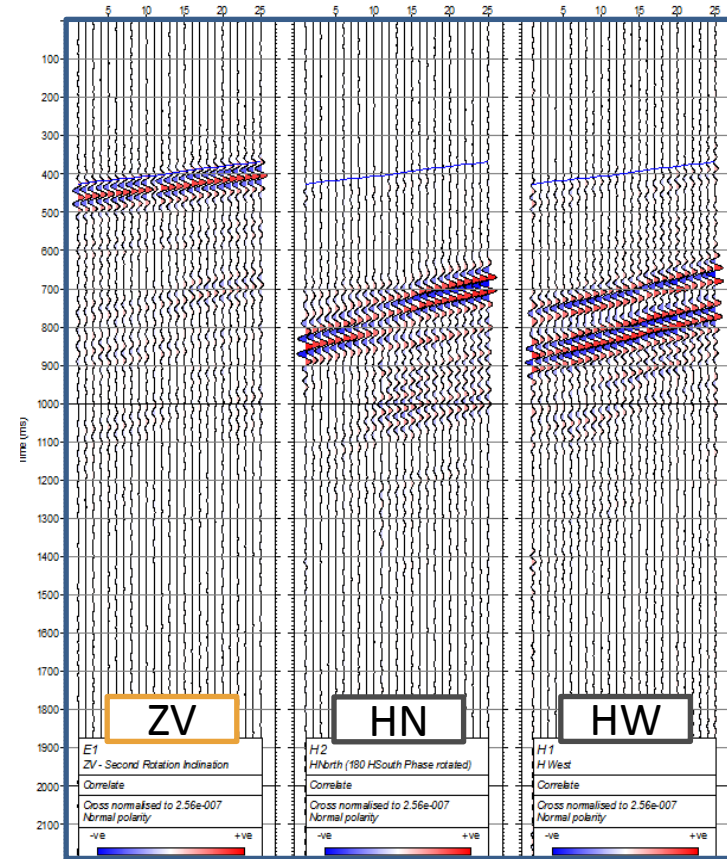

References

- *EULER angles*: https://en.wikipedia.org/wiki/Euler_angles
- Naville, C., Serbutoviez, S. and Lecomte, J. [2012] *Method for time picking and orientation of three-component seismic signals in wells*; Patent US2012_0046871A1
- Wills, W., Naville, C., and Nott-Bower, M. Tubridy, G. [2017] *Orientation of a 3-C VSP dataset acquired by integrated geophone sensor and MEMS inclinometer devices; 3C VSP orientation field QC*. Fourth EAGE BGW Abu Dhabi Proceedings 2017.